

SIEMENS

SINAMICS

SINAMICS G120 CU240B-2 and CU240E-2 Control Units

Compact Operating Instructions

Fundamental safety instructions	1
Scope of delivery	2
Installing	3
Commissioning	4
More information	5

Edition 01/2017



01/2017
A5E39910322B AA



Legal information

Warning notice system

This manual contains notices you have to observe in order to ensure your personal safety, as well as to prevent damage to property. The notices referring to your personal safety are highlighted in the manual by a safety alert symbol, notices referring only to property damage have no safety alert symbol. These notices shown below are graded according to the degree of danger.

 DANGER
indicates that death or severe personal injury will result if proper precautions are not taken.
 WARNING
indicates that death or severe personal injury may result if proper precautions are not taken.
 CAUTION
indicates that minor personal injury can result if proper precautions are not taken.
NOTICE
indicates that property damage can result if proper precautions are not taken.

If more than one degree of danger is present, the warning notice representing the highest degree of danger will be used. A notice warning of injury to persons with a safety alert symbol may also include a warning relating to property damage.

Qualified Personnel

The product/system described in this documentation may be operated only by **personnel qualified** for the specific task in accordance with the relevant documentation, in particular its warning notices and safety instructions. Qualified personnel are those who, based on their training and experience, are capable of identifying risks and avoiding potential hazards when working with these products/systems.

Proper use of Siemens products

Note the following:

 WARNING
Siemens products may only be used for the applications described in the catalog and in the relevant technical documentation. If products and components from other manufacturers are used, these must be recommended or approved by Siemens. Proper transport, storage, installation, assembly, commissioning, operation and maintenance are required to ensure that the products operate safely and without any problems. The permissible ambient conditions must be complied with. The information in the relevant documentation must be observed.

Trademarks

All names identified by ® are registered trademarks of Siemens AG. The remaining trademarks in this publication may be trademarks whose use by third parties for their own purposes could violate the rights of the owner.

Disclaimer of Liability

We have reviewed the contents of this publication to ensure consistency with the hardware and software described. Since variance cannot be precluded entirely, we cannot guarantee full consistency. However, the information in this publication is reviewed regularly and any necessary corrections are included in subsequent editions.

Table of contents

1	Fundamental safety instructions	4
1.1	General safety instructions	4
1.2	Industrial security	5
2	Scope of delivery	6
3	Installing	7
3.1	Plugging the Control Unit onto the Power Module.....	7
3.2	Overview of the interfaces	9
3.3	Terminal strips on CU240B-2 Control Units.....	11
3.4	Factory setting of the CU240B-2 interfaces.....	13
3.5	Terminal strips on CU240E-2 Control Units.....	15
3.6	Factory setting of the CU240E-2 interfaces.....	17
4	Commissioning	19
4.1	Tools to commission the converter	19
4.2	Commissioning with BOP-2 operator panel.....	20
4.2.1	Quick commissioning with the BOP-2.....	20
4.2.2	Standard Drive Control	22
4.2.3	Dynamic Drive Control	24
4.2.4	Identifying the motor data and optimizing the closed-loop control	26
4.3	Connecting the inverter to the fieldbus	28
4.4	Frequently required parameters	30
5	More information	33
5.1	Overview of the manuals	33
5.2	Technical support.....	34

This manual describes how you install the CU240B-2 or CU240E-2 Control Unit of the SINAMICS G120 inverter and commission it.

What is the meaning of the symbols in the manual?



Reference to further information in the manual



1. An operating instruction starts here.
2.



This concludes the operating instruction.



Download from the Internet



DVD that can be ordered

1

Fundamental safety instructions

1.1 General safety instructions

 **WARNING**

Danger to life if the safety instructions and residual risks are not observed

If the safety instructions and residual risks in the associated hardware documentation are not observed, accidents involving severe injuries or death can occur.

- Observe the safety instructions given in the hardware documentation.
- Consider the residual risks for the risk evaluation.

 **WARNING**

Danger to life or malfunctions of the machine as a result of incorrect or changed parameterization

As a result of incorrect or changed parameterization, machines can malfunction, which in turn can lead to injuries or death.

- Protect the parameterization (parameter assignments) against unauthorized access.
- Respond to possible malfunctions by applying suitable measures (e.g. EMERGENCY STOP or EMERGENCY OFF).

1.2 Industrial security

Note

Industrial security

Siemens provides products and solutions with industrial security functions that support the secure operation of plants, systems, machines and networks.

In order to protect plants, systems, machines and networks against cyber threats, it is necessary to implement – and continuously maintain – a holistic, state-of-the-art industrial security concept. Siemens products and solutions only represent one component of such a concept.

The customer is responsible for preventing unauthorized access to its plants, systems, machines and networks. Systems, machines and components should only be connected to the enterprise network or the internet if and to the extent necessary and with appropriate security measures (e.g. use of firewalls and network segmentation) in place.

Additionally, Siemens' guidance on appropriate security measures should be taken into account. For more information about industrial security, please visit:

Industrial security (<http://www.siemens.com/industrialsecurity>).

Siemens' products and solutions undergo continuous development to make them more secure. Siemens strongly recommends to apply product updates as soon as available and to always use the latest product versions. Use of product versions that are no longer supported, and failure to apply latest updates may increase customer's exposure to cyber threats.

To stay informed about product updates, subscribe to the Siemens Industrial Security RSS Feed at:

Industrial security (<http://www.siemens.com/industrialsecurity>).

WARNING

Danger to life as a result of unsafe operating states resulting from software manipulation

Software manipulations (e.g. viruses, trojans, malware or worms) can cause unsafe operating states in your system that may lead to death, serious injury, and property damage.

- Keep the software up to date.
- Incorporate the automation and drive components into a holistic, state-of-the-art industrial security concept for the installation or machine.
- Make sure that you include all installed products into the holistic industrial security concept.
- Protect files stored on exchangeable storage media from malicious software by with suitable protection measures, e.g. virus scanners.

2

Scope of delivery

The delivery comprises at least the following components:



- A CU240B-2 or a CU240E-2 control unit with firmware, which is ready to run. Options for upgrading and downgrading the firmware can be found on the Internet: Firmware (<http://support.automation.siemens.com/WW/news/en/67364620>)

The fieldbus interface of the Control Unit depends on the Article No. The Article No., the designation and the version of the hardware (e.g. 02) and firmware (e.g. 4.6) can be found on the rating plate ① of the Control Unit.

	Designation	Article number	Fieldbus
	CU240B-2	6SL3244-0BB00-1BA1	USS, Modbus RTU
	CU240B-2 DP	6SL3244-0BB00-1PA1	PROFIBUS DP
	CU240E-2	6SL3244-0BB12-1BA1	USS, Modbus RTU
	CU240E-2 F	6SL3244-0BB13-1BA1	
	CU240E-2 DP	6SL3244-0BB12-1PA1	PROFIBUS DP
	CU240E-2 DP-F	6SL3244-0BB13-1PA1	
	CU240E-2 PN	6SL3244-0BB12-1FA0	PROFINET IO, EtherNet/IP
	CU240E-2 PN-F	6SL3244-0BB13-1FA0	

- Compact Operating Instructions in German and English
- The inverter contains open-source software (OSS). The OSS license terms are saved in the inverter.

Transferring OSS license terms to a PC

Procedure



1. To transfer OSS license terms to a PC, proceed as follows:

1. Switch off the inverter power supply.
2. Insert an empty memory card into the card slot of the inverter.



Overview of the interfaces (Page 9)

3. Switch on the inverter power supply.
4. The inverter writes file "Read_OSS.ZIP" to the memory card within approximately 30 seconds.
5. Switch off the inverter power supply.
6. Withdraw the memory card from the inverter.
7. Insert the memory card into the card reader of a PC.
8. Please read the license terms.



You have transferred the OSS license terms to a PC.

Installing

3.1 Plugging the Control Unit onto the Power Module

Permissible Power Modules

You may operate the Control Unit with the following Power Modules:

Power Module	✓ = operation with Power Module permissible, --- = not permissible	
	CU240B-2	CU240E-2
PM230 IP20 and push-through	✓	✓
PM230 IP55	---	✓
PM240P-2	✓	✓
PM240-2	✓	✓
PM250	✓	✓

Installing the Control Unit - General

Each Power Module has an appropriate holder for the Control Unit and a release mechanism.

Inserting the Control Unit

- ➔ 1. Proceed as follows to plug the Control Unit onto a Power Module:
2.

1. Place the two catches of the Control Unit in the matching grooves of the Power Module.
2. Press the Control Unit onto the Power Module until you hear that it latches.

- You have now plugged the Control Unit onto the Power Module.

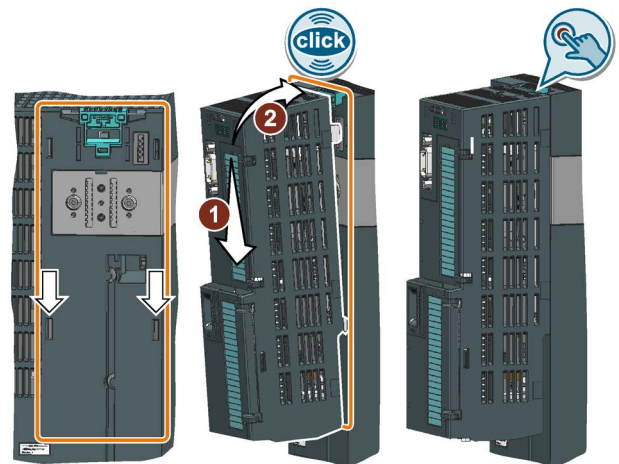

Removing the Control Unit

Remove the Control Unit from the Power Module by pressing the release mechanism.

Special features for the PM230 Power Module IP55, FSA ... FSC

To insert or detach the Control Unit, you must release eight or ten fixing screws of the cover and then remove the cover.

The Power Module release mechanism is shown in the diagram.

Attach the cover again before you commission the inverter. Do not damage the seal of the cover when attaching it.

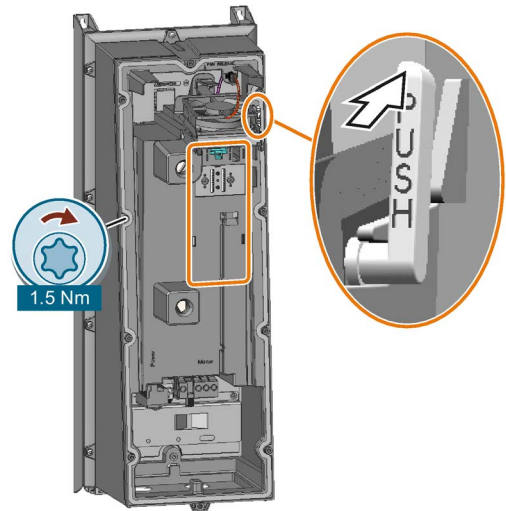

Adapter for operating a PM230 IP55 Power Module



For operating the Control Unit with a PM230 IP55 Power Module, FSA ... FSC, an adapter is required between the Control Unit and operator panel (BOP-2 or IOP).

The adapter, which is included in the scope of delivery of the Power Module, is too short for the CU240E-2 Control Unit. The matching adapter for the CU240E-2 Control Unit can be ordered through the KnorrTec company.

Article number 10055500

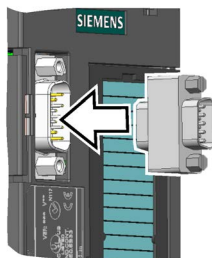
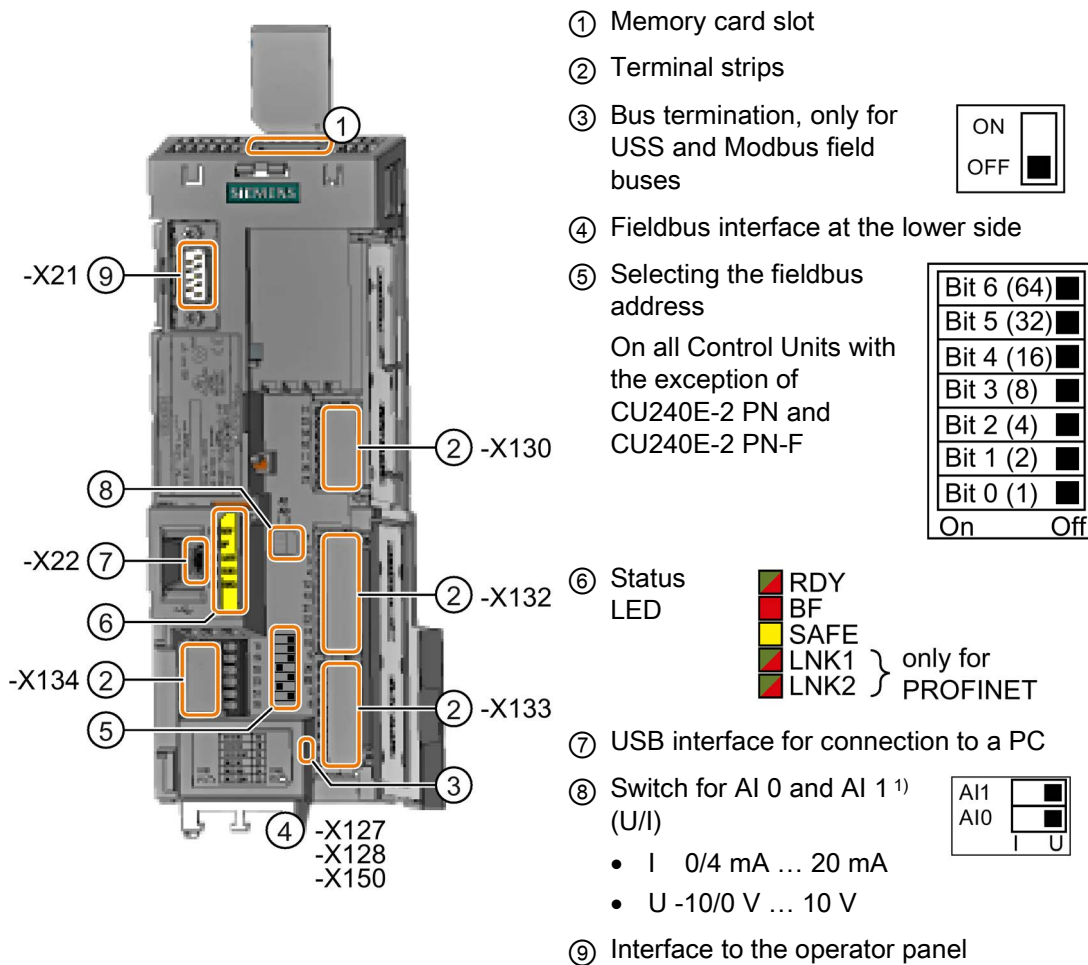

Figure 3-1 Insert the KnorrTec adapter on the interface for the operator panel

3.2 Overview of the interfaces

Interfaces at the front of the Control Unit

To access the interfaces at the front of the Control Unit, you must lift the Operator Panel (if one is being used) and open the front doors.



¹⁾ AI 1 is not available on the CU240B-2 Control Unit

Table 3- 1 Number of inputs and outputs

	Digital inputs DI	Digital outputs DO	Analog inputs AI	Analog outputs AO	Fail-safe digital inputs F-DI ¹⁾
CU240B-2, CU240B-2 DP	4	1	1	1	0
CU240E-2, CU240E-2 DP, CU240E-2 PN	6	3	2	2	1
CU240E-2 F, CU240E-2 DP-F, CU240E-2 PN-F	6	3	2	2	3

¹⁾ Each fail-safe digital input F-DI used takes up two digital inputs DI

Table 3-2 Permissible cable and wiring options

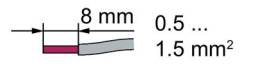
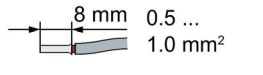
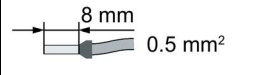
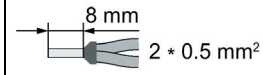
Solid or flexible conductors	Finely stranded conductor with non-insulated end sleeve	Finely stranded conductor with partially insulated end sleeve	Two finely stranded conductors with the same cross-section with partially insulated twin end sleeves
 8 mm 0.5 ... 1.5 mm ²	 8 mm 0.5 ... 1.0 mm ²	 8 mm 0.5 mm ²	 8 mm 2 * 0.5 mm ²

Wiring the terminal strip in compliance with EMC

- If you use shielded cables, then you must connect the shield to the mounting plate of the control cabinet or with the shield support of the inverter through a good electrical connection and a large surface area.
- Use the shield connection plate of the Control Unit as shield support and strain relief.

Table 3-3 Article numbers

Shield connection kit 2 for the CU240B-2 and CU240E-2 Control Units with all fieldbus interfaces except for PROFINET.	6SL3264-1EA00-0HA0
Shield connection kit 3 for the CU230P-2 and CU240E-2 Control Units with PROFINET interface	6SL3264-1EA00-0HB0



Additional information about EMC-compliant wiring is available on the Internet: EMC installation guideline (<http://support.automation.siemens.com/WW/view/en/60612658>)

Interfaces at the lower side of the CU240B-2 and CU240E-2 Control Units

RS485 plug for USS and Modbus RTU (X128)

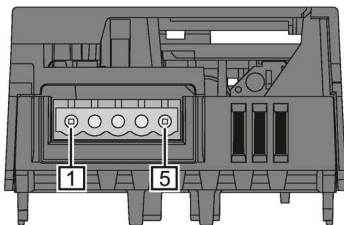

- Pin
- 1 0 V, reference potential
 - 2 RS485P, receive and transmit (+)
 - 3 RS485N, receive and transmit (-)
 - 4 Cable shield
 - 5 Not connected

RJ45 connector socket for PROFINET IO (X150 P1, X150 P2)

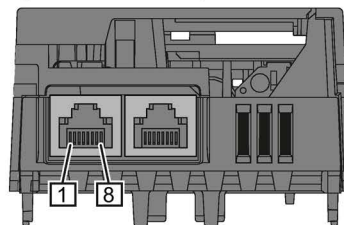

- Pin
- 1 RX+, receive data +
 - 2 RX-, receive data -
 - 3 TX+, Transmit data +
 - 4 Not assigned
 - 5 Not assigned
 - 6 TX-, transmit data -
 - 7 Not assigned
 - 8 Not assigned

SUB-D socket for PROFIBUS DP (X126)

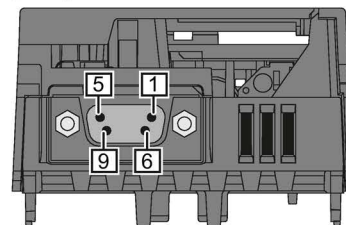

- Pin
- 1 Shield, grounding connection
 - 2 Not assigned
 - 3 RxD/TxD-P, receive and transmit (B/B')
 - 4 CNTR-P, control signal
 - 5 DGND, reference potential for data (C/C')
 - 6 VP, supply voltage
 - 7 Not assigned
 - 8 RxD/TxD-N, receive and transmit (A/A')
 - 9 Not assigned

3.3 Terminal strips on CU240B-2 Control Units

Terminal strips with wiring example

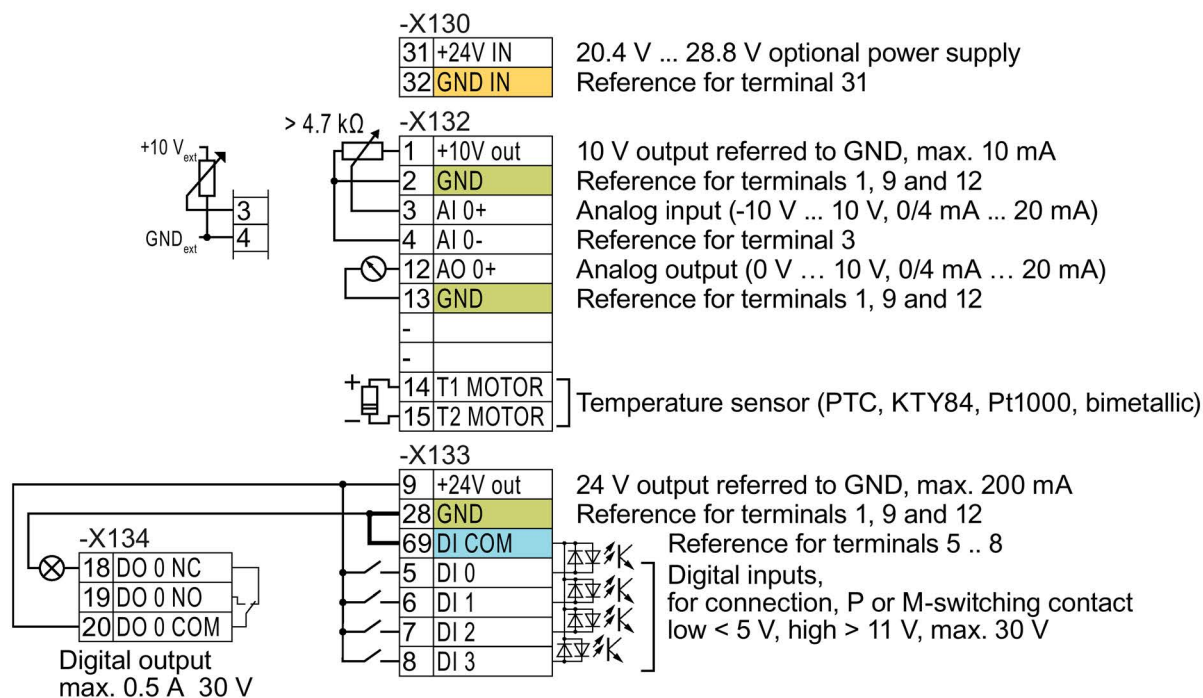

Figure 3-2 Wiring example of the digital inputs with the internal inverter 24 V power supply

GND All terminals labelled with reference potential "GND" are connected internally in the inverter.

DI COM Reference potential "DI COM" is electrically isolated from "GND".

→ if, as described above, you use the 24-V power supply from terminal 9 to supply the digital inputs, then you must connect "GND" with "DI COM" at the terminals.

31 +24 V IN
32 GND IN When an optional 24-V power supply is connected to terminals 31, 32, the Control Unit remains in operation even after the Power Module has been disconnected from the line supply. The Control Unit thus maintains the fieldbus communication, for example.

→ At terminals 31, 32, only connect a power supply that is in accordance with SELV (Safety Extra Low Voltage) or PELV (Protective Extra Low Voltage).

→ if you also wish to use the power supply at terminals 31, 32 for the digital inputs, then you must connect "DI COM" and "GND IN" with one another at the terminals.

3 AI 0+
4 AI 0- You may use the internal 10V power supply or an external power supply for the analog input.

→ If you use the internal 10 V power supply, you must connect AI 0- to GND.

Additional options for wiring the digital inputs

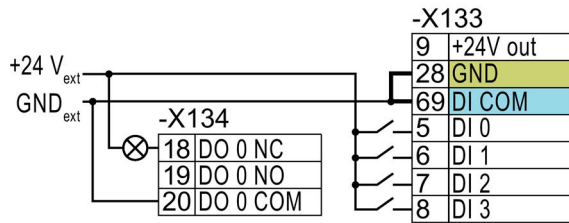

Connecting P-switching contacts with an external power supply

You must remove the jumper between terminals 28 and 69 if it is necessary to have electrical isolation between the external power supply and the internal inverter power supply.

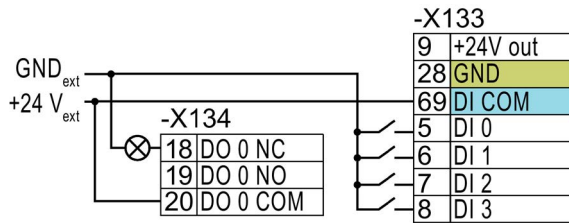

Connecting M-switching contacts with an external power supply

It is not permissible that terminals 28 and 69 are connected with one another.

3.4 Factory setting of the CU240B-2 interfaces

The factory setting of the terminals depends on which fieldbus the Control Unit supports.

Control Units with PROFIBUS interface

The function of the fieldbus interface and digital inputs DI 0, DI 1 depends on DI 3.

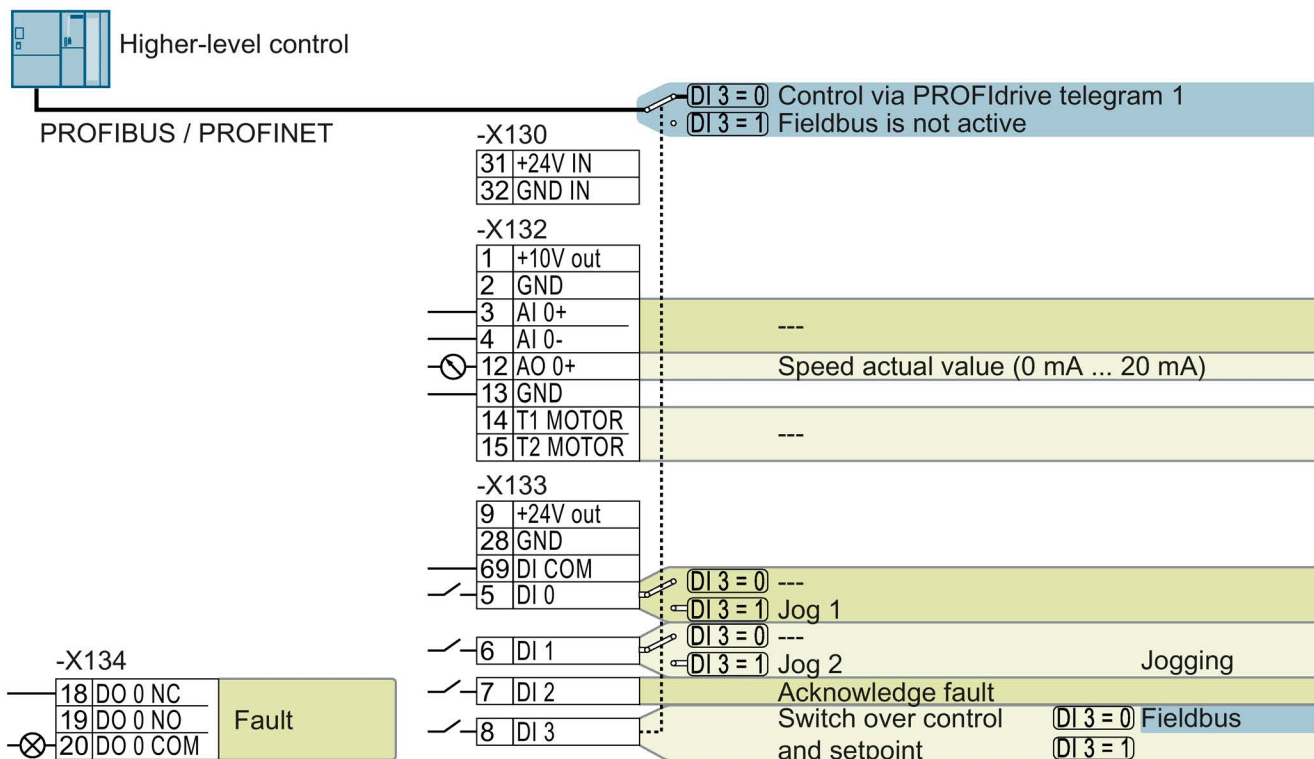

--- No function.

DO 0: p0730

AO 0: p0771[0]

DI x: r0722.x

Speed setpoint (main setpoint): p1070[0] = 2050[1]

Figure 3-3 Factory setting of the CU240B-2 DP Control Unit

Control Units with USS interface

The fieldbus interface is not active.

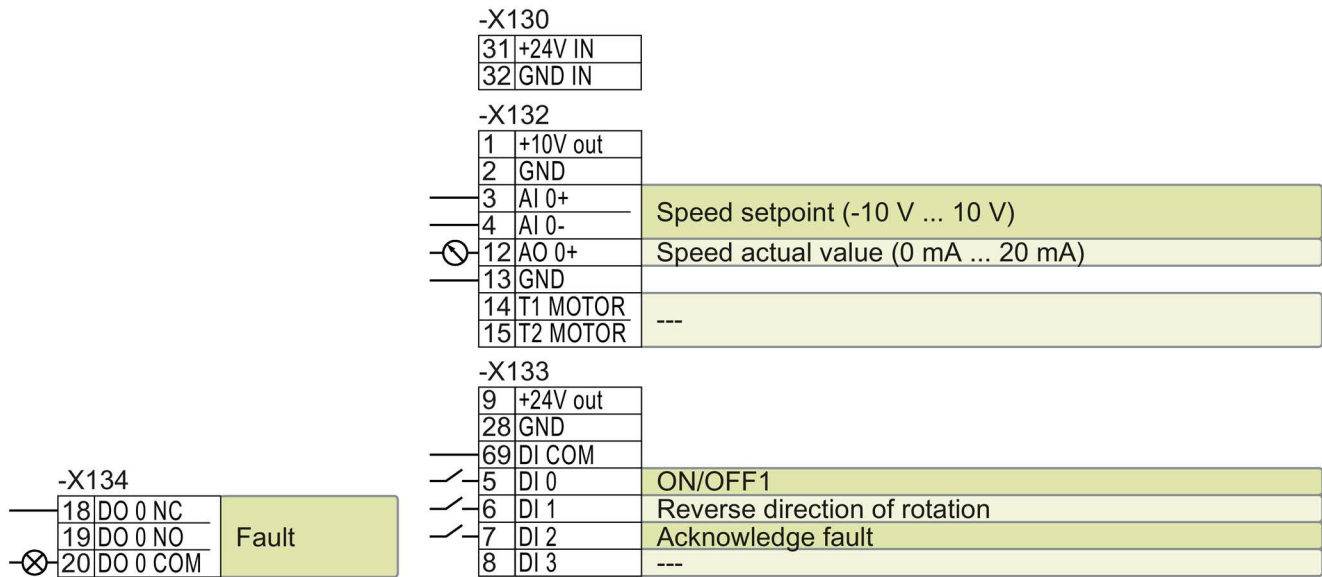

--- No function.

DO 0: p0730

AO 0: p0771[0]

DI x: r0722.x

AI 0: r0755[0]

Speed setpoint (main setpoint): p1070[0] = 755[0]

Figure 3-4 Factory setting of the CU240B-2 Control Unit

Changing the function of the terminals

The function of the terminals marked in color in the two figures above, can be set.

In order that you do not have to successively change terminal for terminal, several terminals can be jointly set using default settings ("p0015 Macro drive unit").

The terminal settings made in the factory described above correspond to the following default settings:

- Default setting 12 (p0015 = 12): "Standard I/O with analog setpoint"
- Default setting 7 (p0015 = 7): "Fieldbus with data set switchover"

Further default settings can be found in the Operating Instructions.

 Overview of the manuals (Page 33)

3.5 Terminal strips on CU240E-2 Control Units

Terminal strips with wiring example

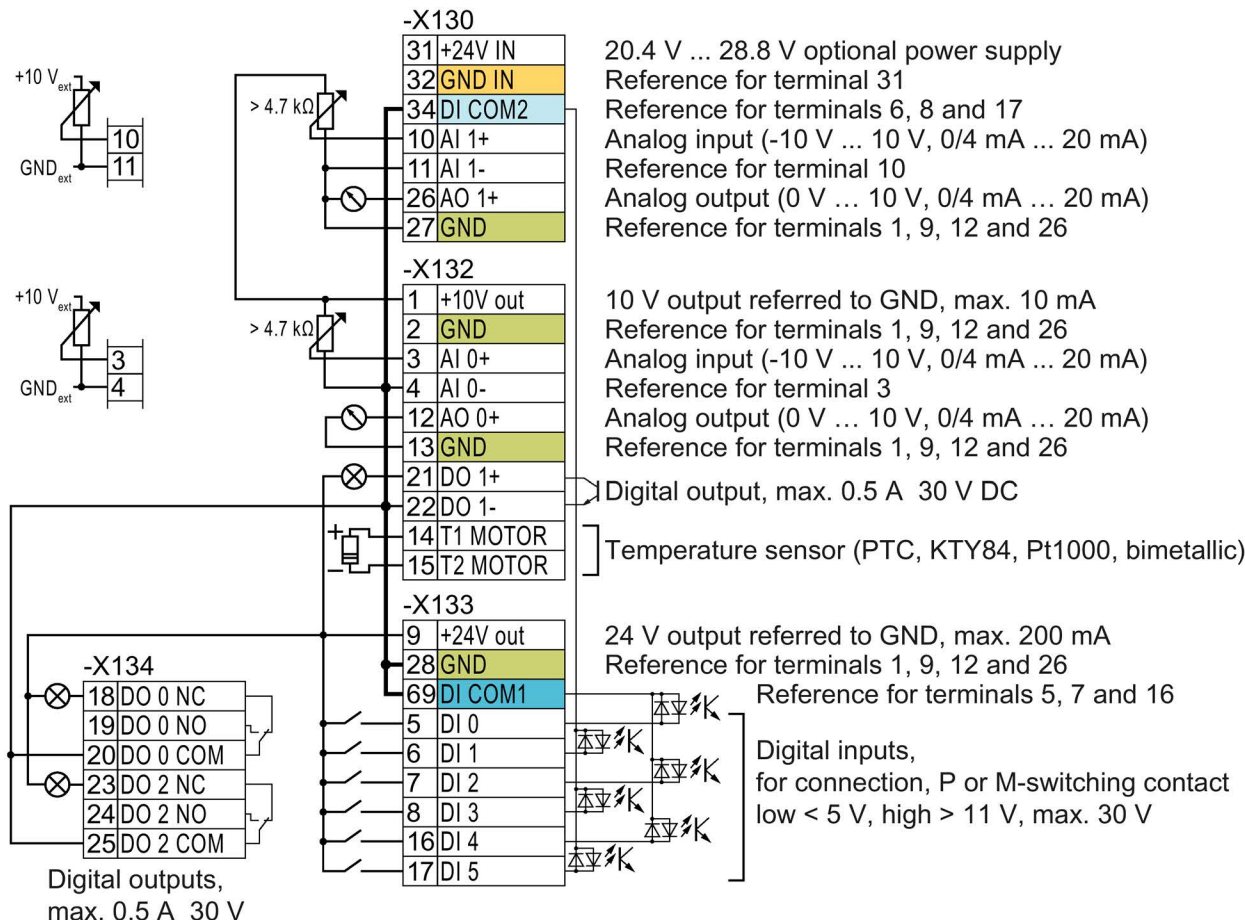
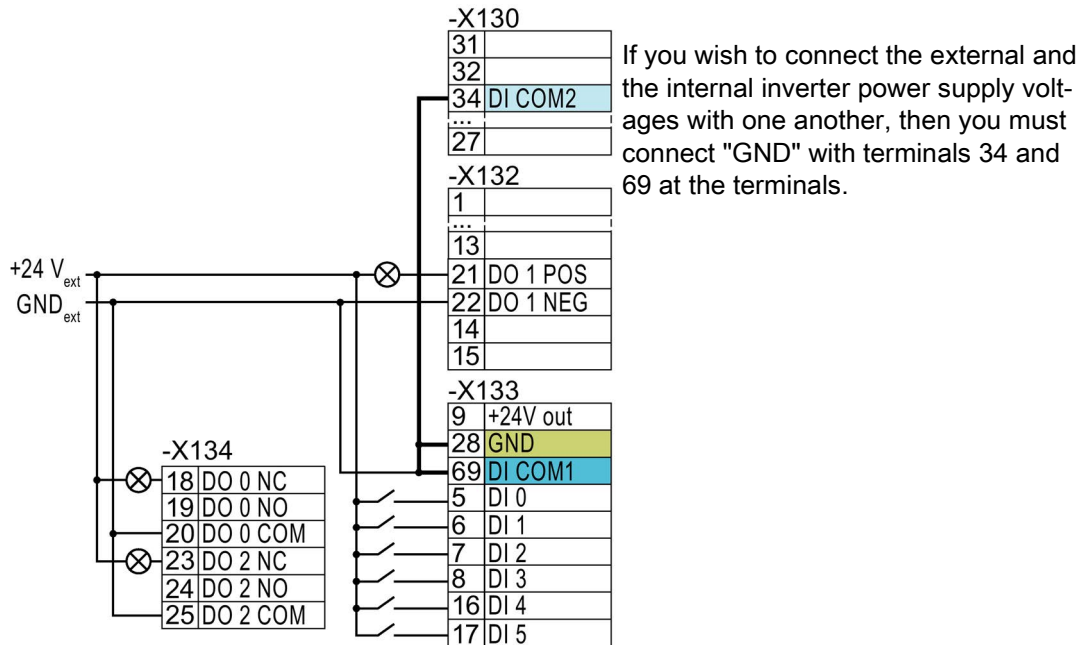

Figure 3-5 Wiring example of the digital inputs with the internal inverter 24 V power supply

- GND** All terminals labelled with reference potential "GND" are connected internally in the inverter.
- DI COM1** Reference potentials "DI COM1" and "DI COM2" are electrically isolated from "GND".
- DI COM2** → if, as described above, you use the 24-V power supply from terminal 9 to supply the digital inputs, then you must connect "GND" with "DI COM1" and "DI COM2" at the terminals.
- 31 +24 V IN** When an optional 24-V power supply is connected to terminals 31, 32, the Control Unit remains in operation even after the Power Module has been disconnected from the line supply. The Control Unit thus maintains the fieldbus communication, for example.
→ At terminals 31, 32, only connect a power supply that is in accordance with SELV (Safety Extra Low Voltage) or PELV (Protective Extra Low Voltage).
→ if you also wish to use the power supply at terminals 31, 32 for the digital inputs, then you must connect "DI COM1/2" and "GND IN" with one another at the terminals.
- 32 GND IN**
- 3 AI 0+** You may use the internal 10V power supply or an external power supply for the analog inputs.
4 AI 0-
- 10 AI 1+** → If you use the internal 10 V power supply, you must connect AI 0- or AI 1- to GND.
11 AI 1-

Additional options for wiring the digital inputs



If you wish to connect the external and the internal inverter power supply voltages with one another, then you must connect "GND" with terminals 34 and 69 at the terminals.

Connecting P-switching contacts with an external power supply

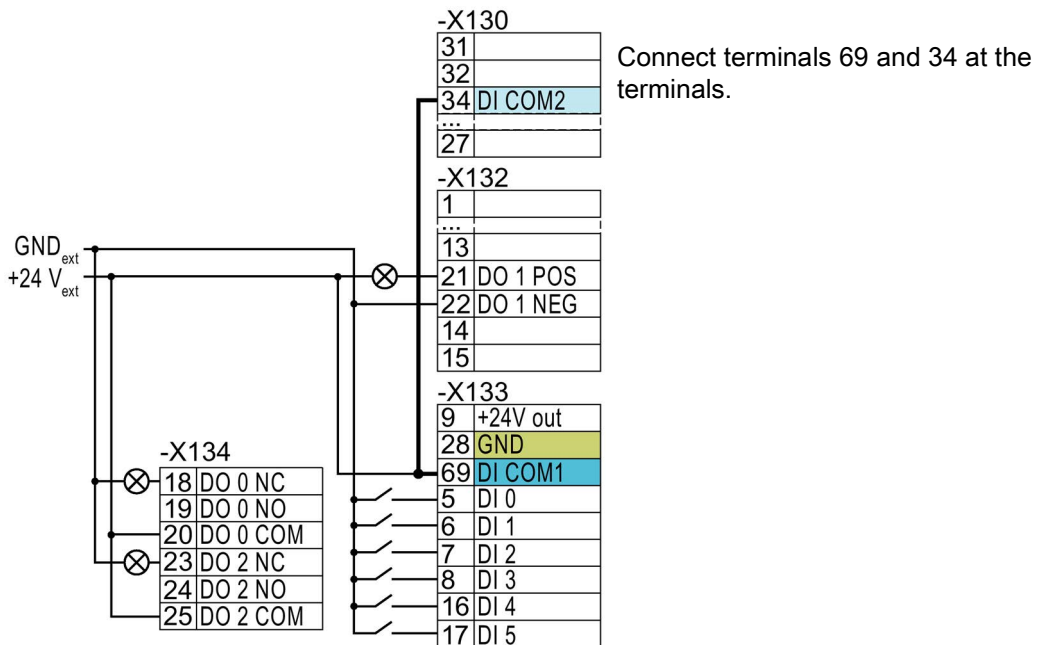

Connect terminals 69 and 34 at the terminals.

Connecting M-switching contacts with an external power supply

3.6 Factory setting of the CU240E-2 interfaces

The factory setting of the terminal strip depends on the Control Unit.

Control Units with PROFIBUS or PROFINET interface

The function of the fieldbus interface and digital inputs DI 0, DI 1 depends on DI 3.

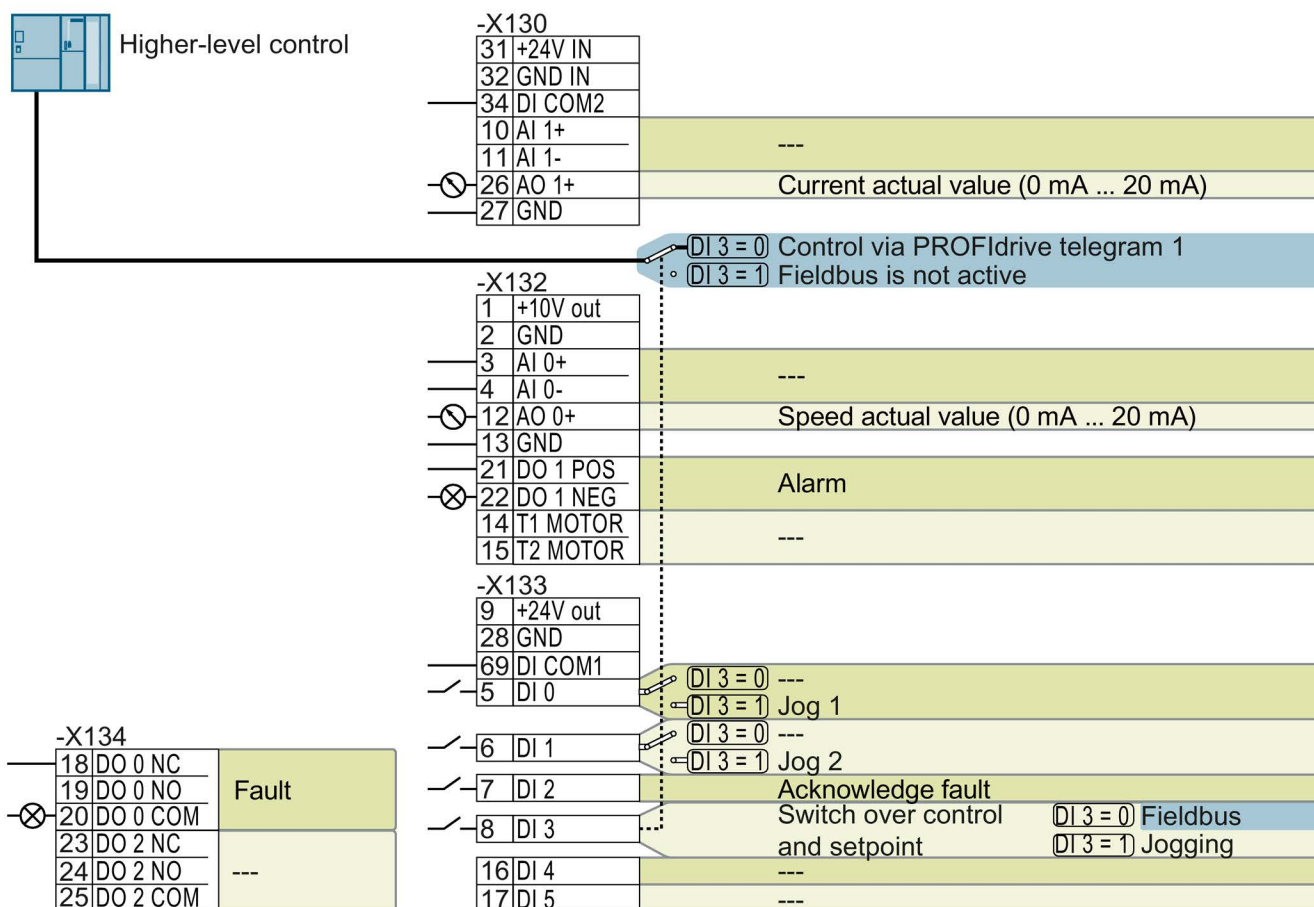

--- No function.

DO x: p073x

AO 0: p0771[0]

DI x: r0722.x

Speed setpoint (main setpoint): p1070[0] = 2050[1]

Figure 3-6 Factory setting of CU240E-2 DP(-F) and CU240E-2 PN(-F) Control Units

Control Units with USS interface

The fieldbus interface is not active.

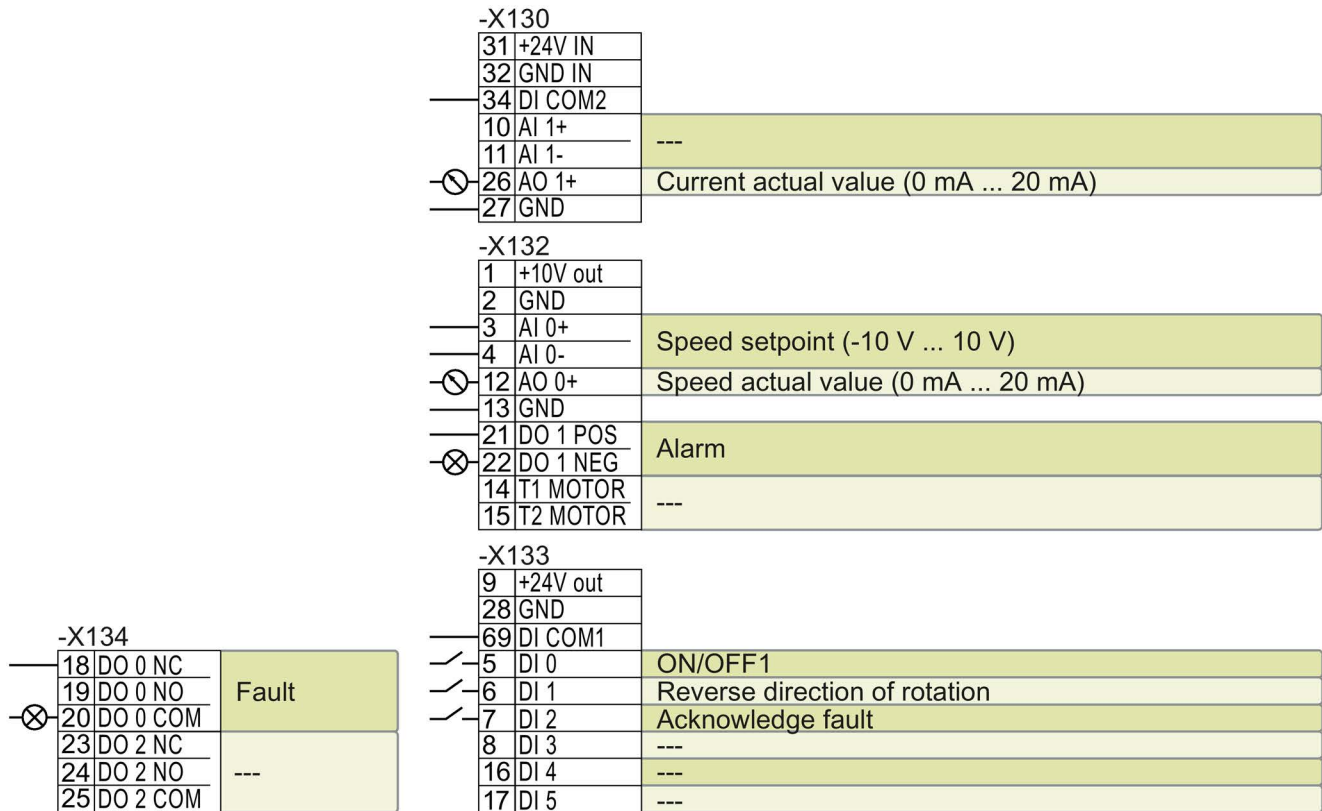

--- No function.

DO x: p073x

AO 0: p0771[0]

DI x: r0722.x

AI 0: r0755[0]

Speed setpoint (main setpoint): p1070[0] = 755[0]

Figure 3-7 Factory setting of the CU240E-2 and CU240E-2 F Control Units

Changing the function of the terminals

The function of the terminals marked in color in the two figures above, can be set.

In order that you do not have to successively change terminal for terminal, several terminals can be jointly set using default settings ("p0015 Macro drive unit").

The terminal settings made in the factory described above correspond to the following default settings:

- Default setting 12 (p0015 = 12): "Standard I/O with analog setpoint"
- Default setting 7 (p0015 = 7): "Fieldbus with data set switchover"

Further default settings can be found in the Operating Instructions.

 Overview of the manuals (Page 33)

Commissioning

4.1 Tools to commission the converter

Operator panel

An operator panel is used to commission, troubleshoot and control the inverter, as well as to back up and transfer the inverter settings.



The **Intelligent Operator Panel (IOP)** is available for snapping onto the inverter, or as handheld with a connecting cable to the inverter. The graphics-capable plain text display of the IOP enables intuitive operation and diagnostics of the inverter.

The IOP is available in two versions:

- With European languages
- With Chinese, English and German

Additional information about the compatibility of the IOP and inverters is available in the Internet:



Compatibility of the IOP and Control Units
<http://support.automation.siemens.com/WW/view/en/67273266>



The **Operator Panel BOP-2** for snapping onto the inverter has a two-line display for diagnostics and operating the inverter.

Operating Instructions of the BOP-2 and IOP operator panels:



Overview of the manuals (Page 33)

PC tools

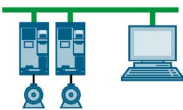

STARTER and **Startdrive** are PC tools that are used to commission, troubleshoot and control the inverter, as well as to back up and transfer the inverter settings. You can connect the PC with the inverter via USB or via the PROFIBUS / PROFINET fieldbus.

Connecting cable (3 m) between PC and inverter: Article number 6SL3255-0AA00-2CA0



STARTER DVD: Article number 6SL3072-0AA00-0AG0

Startdrive DVD: Article number 6SL3072-4CA02-1XG0



STARTER <http://support.automation.siemens.com/WW/view/en/26233208>

Startdrive <http://support.automation.siemens.com/WW/view/en/68034568>



STARTER videos <http://www.automation.siemens.com/mcms/mc-drives/en/low-voltage-inverter/sinamics-g120/videos/Pages/videos.aspx>

Startdrive tutorial <http://support.automation.siemens.com/WW/view/en/73598459>

4.2 Commissioning with BOP-2 operator panel

Plugging on an operator panel

Procedure



1. To plug an Operator Panel on the Control Unit, proceed as follows:
- 2.

1. Locate the lower edge of the Operator Panel into the matching recess of the Control Unit.
2. Plug the Operator Panel onto the inverter until the latch audibly engages.



You have plugged an operator panel onto the Control Unit.

The operator panel is ready for operation when you connect the inverter to the power supply.

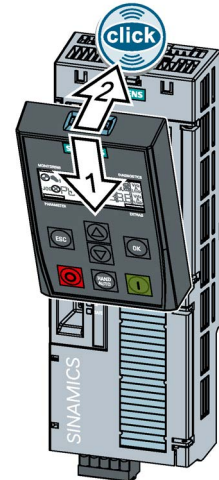

4.2.1 Quick commissioning with the BOP-2

Starting quick commissioning

Preconditions

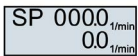

- The power supply is switched on.
- The operator panel displays setpoints and actual values.

Procedure



1. Proceed as follows to carry out quick commissioning:
- 2.



Press the ESC key.



Press one of the arrow keys until the BOP-2 displays the "SETUP" menu.



To start quick commissioning, in the "SETUP" menu, press the OK key.





If you wish to restore all of the parameters to the factory setting before the quick commissioning, proceed as follows:

1. Press the OK key.
2. Switchover the display using an arrow key: nO → YES
3. Press the OK key.

DRV APPL
P96

When selecting an application class, the inverter assigns the appropriate default settings to the motor control:

-  Standard Drive Control (Page 22)
-  Dynamic Drive Control (Page 24)
- EXPERT: This procedure is described in the operating instructions.
-  Overview of the manuals (Page 33)

Selecting a suitable application class

When selecting an application class, the inverter assigns the appropriate settings to the motor control.

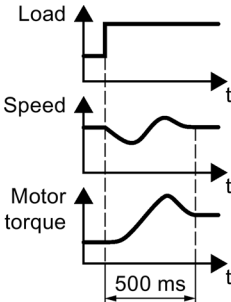
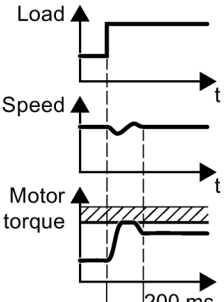
Application class	Standard Drive Control	Dynamic Drive Control
Characteristics	<ul style="list-style-type: none"> • Typical settling time after a speed change: 100 ms ... 200 ms • Typical settling time after a sudden load change: 500 ms • Standard Drive Control is suitable for the following requirements: <ul style="list-style-type: none"> – Motor power ratings < 45 kW – Ramp-up time 0 → Rated speed (dependent on the rated motor power): 1 s (0.1 kW) ... 10 s (45 kW) – Applications with constant load torque without load surges • Standard Drive Control is insensitive to inaccurate motor data settings 	<ul style="list-style-type: none"> • Typical settling time after a speed change: < 100 ms • Typical settling time after a sudden load change: 200 ms • Dynamic Drive Control controls and limits the motor torque • Torque accuracy that can be achieved: $\pm 5\%$ for 15 % ... 100 % of the rated speed • We recommend Dynamic Drive Control for the following applications: <ul style="list-style-type: none"> – Motor power ratings > 11 kW – For load surges of 10 % ... >100 % of the rated motor torque • Dynamic Drive Control is necessary for a ramp-up time 0 → rated speed (dependent on the rated motor power): < 1 s (0.1 kW) ... < 10 s (132 kW). 
Application examples	<ul style="list-style-type: none"> • Pumps, fans, and compressors with flow characteristic • Wet or dry blasting technology • Mills, mixers, kneaders, crushers, agitators • Horizontal conveyor technology (conveyor belts, roller conveyors, chain conveyors) • Basic spindles 	<ul style="list-style-type: none"> • Pumps and compressors with displacement machines • Rotary furnaces • Extruder • Centrifuge
Motors that can be operated	Induction motors	Induction and synchronous motors

Application class	Standard Drive Control	Dynamic Drive Control
Power Modules that can be operated	PM240-2, PM240P-2	
Max. output frequency	550 Hz	240 Hz
Torque control	Without torque control	Speed control with lower-level torque control
Commissioning	<ul style="list-style-type: none"> Contrary to "Dynamic Drive Control" a speed controller does not have to be set In comparison to the "EXPERT" setting: <ul style="list-style-type: none"> Simplified commissioning using pre-assigned motor data Reduced number of parameters Standard Drive Control is preset for Power Modules, frame size A ... frame size C 	<ul style="list-style-type: none"> Reduced parameter quantity when compared to the "EXPERT" setting: Dynamic Drive Control is preset for Power Modules, frame size D ... frame size F

4.2.2 Standard Drive Control

EUR/USA
P100_

Select the motor standard.

- KW 50HZ: IEC
- HP 60HZ: NEMA
- KW 60HZ: IEC 60 Hz

INV VOLT
P210_

Set the inverter supply voltage.

MOT TYPE
P300_

Select the motor type. If a 5-digit motor code is stamped on the motor rating plate, select the corresponding motor type with motor code.

Motors without motor code stamped on the rating plate:

- INDUCT: Third-party induction motor
- 1L... IND: 1LE1, 1LG6, 1LA7, 1LA9 induction motors

Motors with motor code stamped on the rating plate:

- 1LE1 IND 100: 1LE1 . 9
- 1PC1 IND: 1PC1
- 1PH8 IND: Induction motor
- 1FP1: Reluctance motor

Depending on the inverter, the motor list in BOP-2 can deviate from the list shown above.

MOT CODE
P301_

If you have selected a motor type with motor code, you must now enter the motor code. The inverter assigns the following motor data corresponding to the motor code.

If you do not know the motor code, then you must set the motor code = 0, and enter motor data from p0304 and higher from the rating plate.

- 87 HZ
P303

87 Hz motor operation The BOP-2 only indicates this step if you selected IEC as the motor standard (EUR/USA, P100 = KW 50HZ).
- MOT VOLT
P304

Rated motor voltage
- MOT CURR
P305

Rated motor current
- MOT POW
P307

Rated motor power
- MOT FREQ
P310

Rated motor frequency
- MOT RPM
P311

Rated motor speed
- MOT COOL
P335

Motor cooling:

 - SELF: Natural cooling
 - FORCED: Forced-air cooling
 - LIQUID: Liquid cooling
 - NO FAN: Without fan
- TEC APPL
P501

Select the basic setting for the motor control:

 - VEC STD: Constant load; typical applications include conveyor drives
 - PUMP FAN: Speed-dependent load; typical applications include pumps and fans
- MAc PAR
P15

Select the default setting for the interfaces of the inverter that is suitable for your application. The available default settings can be found in the operating instructions.

Overview of the manuals (Page 33)

- MIN RPM
P1080
- MAX RPM
P1082

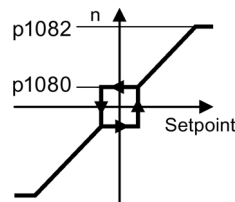

Figure 4-1 Minimum and maximum motor speed

- RAMP UP
P1120
- RAMP DWN
P1121

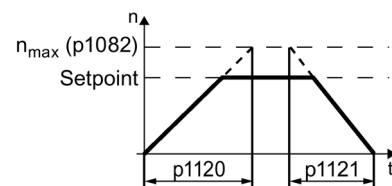

Figure 4-2 Ramp-up and ramp-down time of the motor

- OFF3 RP
P1135

Ramp-down time after the OFF3 command

MOT ID
P1900_

Motor data identification Select the method which the inverter uses to measure the data of the connected motor:

- OFF: No motor data identification
- STILL: Default setting: Measure the motor data at standstill. The inverter switches off the motor after the motor data identification has been completed.

FINISH
_

Complete quick commissioning as follows:

1. Switchover the display using an arrow key: nO → YES
2. Press the OK key.



You have completed quick commissioning.

4.2.3 Dynamic Drive Control

EUR/USA
P100_

Select the motor standard.

- KW 50HZ: IEC
- HP 60HZ: NEMA
- KW 60HZ: IEC 60 Hz

INV VOLT
P210_

Set the inverter supply voltage.

MOT TYPE
P300_

Select the motor type. If a 5-digit motor code is stamped on the motor rating plate, select the corresponding motor type with motor code.

Motors without motor code stamped on the rating plate:

- INDUCT: Third-party induction motor
- 1L... IND: 1LE1, 1LG6, 1LA7, 1LA9 induction motors

Motors with motor code stamped on the rating plate:

- 1LE1 IND 100: 1LE1 . 9
- 1PC1 IND: 1PC1
- 1PH8 IND: Induction motor
- 1FP1: Reluctance motor

Depending on the inverter, the motor list in BOP-2 can deviate from the list shown above.

MOT CODE
P301_

If you have selected a motor type with motor code, you must now enter the motor code. The inverter assigns the following motor data corresponding to the motor code.

If you do not know the motor code, then you must set the motor code = 0, and enter motor data from p0304 and higher from the rating plate.

87 HZ
_

87 Hz motor operation The BOP-2 only indicates this step if you selected IEC as the motor standard (EUR/USA, P100 = KW 50HZ).

MOT VOLT
P304_

Rated motor voltage

MOT CURR P305	Rated motor current
MOT POW P307	Rated motor power
MOT FREQ P310	Rated motor frequency
MOT RPM P311	Rated motor speed
MOT COOL P335	Motor cooling: <ul style="list-style-type: none"> • SELF: Natural cooling • FORCED: Forced-air cooling • LIQUID: Liquid cooling • NO FAN: Without fan
TEC APPL P502	Select the basic setting for the motor control: <ul style="list-style-type: none"> • OP LOOP: Recommended setting for standard applications • CL LOOP: Recommended setting for applications with short ramp-up and ramp-down times. This setting is not suitable for hoisting gear and cranes/lifting gear. • HVY LOAD: Recommended setting for applications with a high break loose torque.
MAc PAr P15	Select the default setting for the interfaces of the inverter that is suitable for your application. The available default settings can be found in the operating instructions.

 Overview of the manuals (Page 33)

MIN RPM
P1080

MAX RPM
P1082

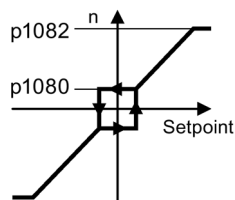

Figure 4-3 Minimum and maximum motor speed

RAMP UP
P1120

RAMP DWN
P1121

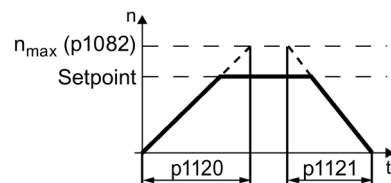

Figure 4-4 Ramp-up and ramp-down time of the motor

OFF3 RP
P1135

Ramp-down time after the OFF3 command

MOT ID
P1900_

Motor data identification: Select the method which the inverter uses to measure the data of the connected motor:

- OFF: Motor data is not measured.
STIL ROT: Recommended setting: Measure the motor data at standstill and with the motor rotating.
The inverter switches off the motor after the motor data identification has been completed.
- STILL: Default setting: Measure the motor data at standstill.
The inverter switches off the motor after the motor data identification has been completed.
Select this setting if the motor cannot rotate freely – for example, if the traversing range is mechanically limited.
- ROT: Measure the motor data with the motor rotating.
The inverter switches off the motor after the motor data identification has been completed.
- ST RT OP: setting same as STIL ROT.
The motor accelerates to the currently set setpoint after the motor data identification.
- STILL OP: setting same as STILL.
After the motor data identification, the motor accelerates to the currently set setpoint.

FINISH

Complete quick commissioning:

- Switch over the display using an arrow key: nO → YES
- Press the OK key.



You have completed quick commissioning.

4.2.4 Identifying the motor data and optimizing the closed-loop control

The inverter has several techniques to automatically identify the motor data and optimize the speed control.

To start the motor data identification routine, you must switch-on the motor via the terminal strip, fieldbus or from the operator panel.



WARNING

Risk of death due to machine motion while motor data identification is active

For the stationary measurement, the motor can make several rotations. The rotating measurement accelerates the motor up to its rated speed. Secure dangerous machine parts before starting motor data identification:

- Before switching on, ensure that nobody is working on the machine or located within its working area.
- Secure the machine's work area against unintended access.
- Lower hanging/suspended loads to the floor.

Preconditions

- You selected a method of motor data identification during quick commissioning, e.g. measuring motor data while the motor is stationary.



When quick commissioning is complete, the inverter issues alarm A07991.

- The motor has cooled down to the ambient temperature.

An excessively high motor temperature falsifies the motor data identification results.

Procedure when using the BOP-2 operator panel

1.
2.

To start the motor data identification, proceed as follows:



Press the HAND/AUTO key.



The BOP-2 displays the symbol indicating manual operation.



Switch on the motor.



During motor data identification, "MOT-ID" flashes on the BOP-2.



If the inverter again outputs alarm A07991, then it waits for a new ON command to start the rotating measurement.

If the inverter does not output alarm A07991, switch off the motor as described below, and switch over the inverter control from HAND to AUTO.



Switch on the motor to start the rotating measurement.



During motor data identification, "MOT-ID" flashes on the BOP-2.

The motor data identification can take up to 2 minutes depending on the rated motor power.



Depending on the setting, after motor data identification has been completed, the inverter switches off the motor - or it accelerates it to the setpoint.

If required, switch off the motor.



Switch the inverter control from HAND to AUTO.



You have completed the motor data identification.

4.3 Connecting the inverter to the fieldbus

Where can I find instructions for the fieldbus connection of the inverter?

Instructions for connecting to a fieldbus can be downloaded from the Internet:



- Application examples (<http://support.automation.siemens.com/WW/view/en/60733299>)
- Operating Instructions: CU240B/E-2 operating instructions (<https://support.industry.siemens.com/cs/ww/en/view/109478828>)
- "Fieldbuses" function manual: Manuals for the Control Unit (<http://support.automation.siemens.com/WW/view/en/30563628/133300>)

Description files for fieldbuses

The description files are electronic device data sheets which contain all the required information of a higher-level controller. You can configure and operate the inverter on a fieldbus with the appropriate description file.



Generic Station Description for PROFIBUS: GSD (<http://support.automation.siemens.com/WW/view/en/23450835>)

GSD Markup Language for PROFINET: GSDML (<http://support.automation.siemens.com/WW/view/en/26641490>)

Ethernet/IP: EDS (<http://support.automation.siemens.com/WW/view/en/78026217>)

Alternative for the download for GSD and GSDML

GSD and GSDML are saved in the inverter. If you set p0804 = 12, then the inverter writes the GSD or the GSDML to the memory card that has been inserted. For instance, you can transfer the file to a PC from the memory card.

Examples for telegrams via PROFIBUS and PROFINET

Telegram 1:

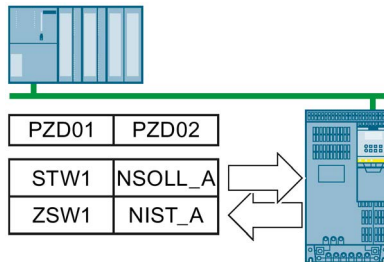

- STW1 Control word 1
- ZSW1 Status word 1
- PZD01/02 Process data 16-bit
- NSOLL_A Speed setpoint
- NIST_A Speed actual value

Control word 1 (STW1), PZD receive word 1 (word: r2050[0], bits: r2090.00 ... r2090.15)

Bit	Meaning	Explanation
0	0 = OFF1	The motor brakes with the ramp-down time p1121 of the ramp-function generator. The inverter switches off the motor at standstill.
	0 → 1 = ON	The inverter goes into the "ready" state. If, in addition bit 3 = 1, then the inverter switches on the motor.
1	0 = OFF2	Switch off the motor immediately, the motor then coasts down to a standstill.
	1 = No OFF2	Precondition in order to be able to switch on the motor using bit 0 (ON command).
2	0 = Quick stop (OFF3)	The motor brakes with the OFF3 ramp-down time p1135 down to standstill.
	1 = No quick stop (OFF3)	Precondition in order to be able to switch on the motor using bit 0 (ON command).
3	0 = Inhibit operation	Switch off the motor immediately → motor coasts down to a standstill.
	1 = Enable operation	Precondition in order to be able to switch on the motor using bit 0 (ON command).
4	0 = Disable RFG	The inverter immediately sets its ramp-function generator output to 0.
	1 = Do not disable RFG	The ramp-function generator can be enabled.
5	0 = Stop RFG	The output of the ramp-function generator stops at the actual value.
	1 = Enable RFG	The output of the ramp-function generator follows the setpoint.
6	0 = Inhibit setpoint	The inverter brakes the motor with the ramp-down time p1121 of the ramp-function generator.
	1 = Enable setpoint	Motor accelerates with the ramp-up time p1120 to the setpoint.
7	0 → 1 = Acknowledge faults	Acknowledge fault. If the ON command is still active (bit 0 = 1), the inverter switches to "closing lockout" state.
8, 9	Reserved	
10	0 = No control via PLC	The inverter ignores the process data from the fieldbus.
	1 = Control via PLC	Control via fieldbus, the inverter accepts the process data from the fieldbus.
11	1 = Direction reversal	Invert setpoint in the inverter.
12	Not used	
13	1 = MOP up	Increase the setpoint saved in the motorized potentiometer.
14	1 = MOP down	Reduce the setpoint saved in the motorized potentiometer.
15	Reserved	
		Changes over between settings for different operation interfaces (command data sets).

4.4 Frequently required parameters

Status word 1 (ZSW1), PZD send word 1 (word: p2051[0], bits: p2080[0] ... p2080[15])

Bit	Meaning	Comments
0	1 = Ready to start	Power supply switched on; electronics initialized; pulses locked.
1	1 = Ready	Motor is switched on (ON/OFF1 = 1), no fault is active. With the command "Enable operation" (STW1.3), the inverter switches on the motor.
2	1 = Operation enabled	Motor follows setpoint. See control word 1, bit 3.
3	1 = Fault active	The inverter has a fault. Acknowledge fault using STW1.7.
4	1 = OFF2 inactive	Coast down to standstill is not active.
5	1 = OFF3 inactive	Quick stop is not active.
6	1 = Closing lockout active	It is only possible to switch on the motor after an OFF1 followed by ON.
7	1 = Alarm active	Motor remains switched on; no acknowledgement is necessary.
8	1 = Speed deviation within the tolerance range	Setpoint / actual value deviation within the tolerance range.
9	1 = Master control requested	The automation system is requested to accept the inverter control.
10	1 = Comparison speed reached or exceeded	Speed is greater than or equal to the corresponding maximum speed.
11	1 = torque limit reached	Comparison value for current or torque has been reached or exceeded.
12	1 = Holding brake open	Signal to open and close a motor holding brake.
13	0 = Alarm, motor overtemperature	--
14	1 = Motor rotates clockwise	Internal inverter actual value > 0
	0 = Motor rotates counter-clockwise	Internal inverter actual value < 0
15	0 = Alarm, inverter thermal overload	

4.4 Frequently required parameters

Parameter	Explanation	
p0015	Macro drive unit Set defaults for inputs and outputs via a macro.	
r0018	Control Unit firmware version	
p0096	Application class	0: Expert 1: Standard Drive Control 2: Dynamic Drive Control
p0100	IEC/NEMA mot stds	0: Europe 50 [Hz] 1: NEMA motor (60 Hz, US units) 2: NEMA motor (60 Hz, SI units)
p0304	Rated motor voltage [V]	
p0305	Rated motor current [A]	
p0307	Rated motor power [kW] or [hp]	
p0310	Rated motor frequency [Hz]	
p0311	Rated motor speed [rpm]	

Parameter	Explanation			
p0601	Motor temperature sensor type			
	Terminal 14	T1 motor (+)	0: No sensor (factory setting) 1: PTC (→ P0604)	
	Terminal 15	T2 motor (-)	2: KTY84 (→ P0604) 4: Bimetal	
p0625	Motor ambient temperature during commissioning [° C]			
p0640	Current limit [A]			
r0722	Digital inputs status			
	.0	Terminal 5	DI 0	Selection of the possible settings:
	.1	Terminal 6	DI 1	p0840 ON/OFF (OFF1) p0844 no coast down (OFF2) p0848 no quick stop (OFF3) p0855 unconditionally release holding brake p1020 fixed speed setpoint selection bit 0 p1021 fixed speed setpoint selection bit 1 p1022 fixed speed setpoint selection bit 2 p1023 fixed speed setpoint selection bit 3 p1035 motorized potentiometer raise setpoint p1036 motorized potentiometer lower setpoint p2103 acknowledge faults p1055 jog bit 0 p1056 jog bit 1
	.2	Terminal 7	DI 2	
	.3	Terminal 8	DI 3	
	.4	Terminal 16	DI 4	
	.5	Terminal 17	DI 5	
	.11	Terminal 3, 4	AI 0	
	.12	Terminal 10, 11	AI 1	
				p1110 inhibit negative direction p1111 inhibit positive direction p1113 setpoint inversion p1122 bypass ramp-function generator p1140 enable/inhibit ramp-function generator p1141 continue/freeze ramp-function generator p1142 enable/inhibit setpoint p1230 DC braking activation p2103 acknowledge faults p2106 external fault 1 p2112 external alarm 1 p2200 technology controller enable
p0730	Signal source for terminal DO 0		Selection of the possible settings:	
	Terminals 19, 20 (NO contact) Terminals 18, 20 (NC contact)		52.0 ready for switching on 52.1 ready for operation	53.0 DC braking active 53.1 n_act > p2167 (n_off)
p0731	Signal source for terminal DO 1		52.2 operation enabled 52.3 fault present	
	Terminals 21, 22 (NO contact)		52.4 coast down active (OFF2)	53.2 n_act ≤ p1080 (n_min) 53.3 l_act > p2170
p0732	Signal source for terminal DO 2		52.5 quick stop active (OFF3) 52.7 alarm present	
	Terminals 24, 25 (NO contact) Terminals 23, 25 (NC contact)		52.14 motor rotates forwards	53.4 n_act > p2155 53.5 n_act ≤ p2155 53.6 n_act ≥ n_set 53.10 technology controller output at lower limit 53.11 technology controller output at upper limit
r0755	Analog inputs actual value [%]			
	[0]	Terminals 3, 4	AI 0	
	[1]	Terminals 10, 11	AI 1	
p0756	Analog input type			0: Unipolar voltage input (0 V ...+10 V) 1: Unipolar voltage input monitored (+2 V... +10 V) 2: Unipolar current input (0 mA ...+20 mA) 3: Unipolar current input monitored (+4 mA ...+20 mA) 4: Bipolar voltage input (-10 V...+10 V)
	[0]	AI 0		
	[1]	AI 1		
p0771	Analog outputs signal source			Selection of the possible settings:
	[0]	Terminals 12, 13	AO 0	0: Analog output locked 21: Speed actual value 24: Output frequency, smoothed 25: Output voltage, smoothed 26: DC link voltage smoothed 27: Actual current value (smoothed absolute value)
	[1]	Terminals 26, 27	AO 1	
p0776	Analog outputs, type			0: Current output (0 mA ... +20 mA) 1: Voltage output (0 V ... +10 V) 2: Current output (+4 mA ... +20 mA)
	[0]	AO 0		
	[1]	AO 1		

4.4 Frequently required parameters

Parameter	Explanation	
p0922	PROFIdrive telegram selection	
p1001	Fixed speed setpoint 1	
p1002	Fixed speed setpoint 2	
p1003	Fixed speed setpoint 3	
p1004	Fixed speed setpoint 4	
p1058	Jog 1 speed setpoint	
p1059	Jog 2 speed setpoint	
p1070	Main setpoint	Selection of the possible settings:
		0: Main setpoint = 0 755[0]: Analog input 0 1024: Fixed setpoint
p1080	Minimum speed [rpm]	
p1082	Maximum speed [rpm]	
p1120	Ramp-function generator ramp-up time [s]	
p1121	Ramp-function generator ramp-down time [s]	
p1300	Open-loop/closed-loop control operating mode	Selection of the possible settings:
		0: U/f control with linear characteristic 1: U/f control with linear characteristic and FCC
p1310	Starting (voltage boost) permanent	
p1800	Pulse frequency setpoint	
p1900	Motor data identification and rotating measurement	
	0: Locked 1: Identify motor data and optimize the speed controller 2: Identify motor data (at standstill) 3: Optimize the speed controller (rotating in operation) 11: Ident. motor data and opt. speed controller, change to operation (not available with PM230 or PM250 Power Module) 12: Identify motor data (at standstill), change to operation (not available with PM230 or PM250 Power Module)	
p2030	Fieldbus interface protocol selection	The possible settings depend on the Control Unit:
		0: No protocol 1: USS 2: Modbus RTU 3: PROFIBUS
r2050	Words received via fieldbus (16 bit) r2050[0]: PZD01 ... r2050[11]: PZD12	
p2051	Words sent via fieldbus (16 bit) p2051[0]: PZD01 ... p2051[16]: PZD17	
p2080	Binector-connector converter, status word 1 p2080[0]: Bit 0 ... p2080[15]: Bit 15	
r2090	PROFIdrive PZD1 receive bit-by-bit (control word 1) r2090.00: Bit 0 ... r2090.15: Bit 15	

More information

5.1 Overview of the manuals





Manuals with additional information that can be downloaded:

- CU240B/E-2 Compact Operating Instructions
<https://support.industry.siemens.com/cs/ww/en/view/109477361>
 Commissioning the inverter (this manual)

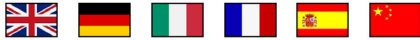

- CU240B/E-2 operating instructions
<https://support.industry.siemens.com/cs/ww/en/view/109482994>
 Installing, commissioning and maintaining the inverter. Advanced commissioning.



- EMC installation guideline
<http://support.automation.siemens.com/WW/view/en/60612658>
 EMC-compliant control cabinet design, potential equalization and cable routing





- CU240B/E-2 List Manual
<https://support.industry.siemens.com/cs/ww/en/view/109482961>
 Parameter lists, alarms and faults. Graphic function diagrams.

- "Fieldbus" function manual
<https://support.industry.siemens.com/cs/ww/en/view/109477369>
 Configuring fieldbuses.

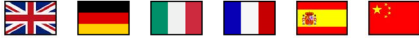

- "Safety Integrated" function manual
<https://support.industry.siemens.com/cs/ww/en/view/109477367>
 Commissioning and optimizing safety functions.



- BOP-2 operating instructions
<https://support.industry.siemens.com/cs/ww/en/view/42185248>
 Using the operator panel.





- IOP operating instructions
(<https://support.industry.siemens.com/cs/ww/en/view/109478559>)
Using the operator panel, door mounting kit for mounting an IOP.

- Application manual IOP (<https://support.industry.siemens.com/cs/ww/en/view/109483443>)
The commissioning wizards in the IOP

- Power Module Installation Manual
(<https://support.industry.siemens.com/cs/ww/en/ps/13224/man>)
Installing Power Modules, reactors and filters. Technical data, maintenance.

- Accessories manual (<https://support.industry.siemens.com/cs/ww/en/ps/13225/man>)
Installation descriptions for inverter components, e.g. line reactors or line filters. The printed installation descriptions are supplied together with the components.



5.2 Technical support

 +49 (0)911 895 7222

 +44 161 446 5545

 +39 (02) 24362000

 +34 902 237 238

 +33 (0) 821 801 122



You can find additional telephone numbers for Technical Support in the Internet:

Product support (<http://www.siemens.com/automation/service&support>)

Further information

SINAMICS converters:
www.siemens.com/sinamics

Safety Integrated
www.siemens.com/safety-integrated

PROFINET
www.siemens.com/profinet

Siemens AG
Digital Factory
Motion Control
Postfach 3180
91050 ERLANGEN
Germany

SINAMICS G120, CU240B/E-2
DOCUMENTATION PACK



Factory processing label - for factory use only

Printed in United Kingdom

Scan the QR code for
additional
information about
SINAMICS G120.

